

Einspeisung  
Alimentation  
Power supply

Der Schutz der Anlage entspricht der geltenden Normen.  
Protection de l'installation conforme aux normes en vigueur.  
Protection of the installation in conformity with the actual norms.

OPTION  
Störung  
Panne  
Trouble

OPTION  
Betriebsstundenzeiger  
Compteurs horaires  
Running hours meter

Erdung nach örtlichen Vorschriften!  
Mise à la terre conformément au réseau local!  
Earthing in accordance with local regulation!

230V 50Hz

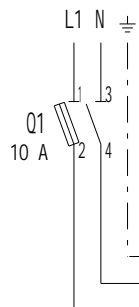

Kessel / Chaudière / Boiler

Sicherheitsebegrenzer  
Th. /pr. sécurité  
Safety limiter

Begrenzer  
Limiteur  
Limiter

2 Stufige  
2 allures  
2 Stages

Prinzipdarstellung  
Schéma de Principe  
Basic circuit diagram

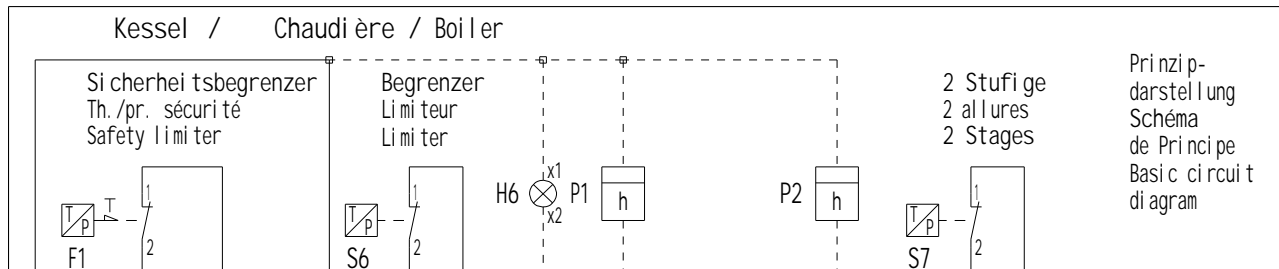

X1S  
X1B

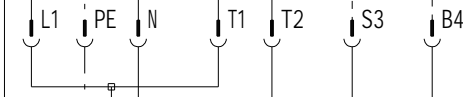

X2S  
X2B

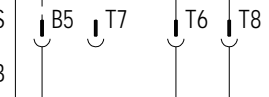

A1

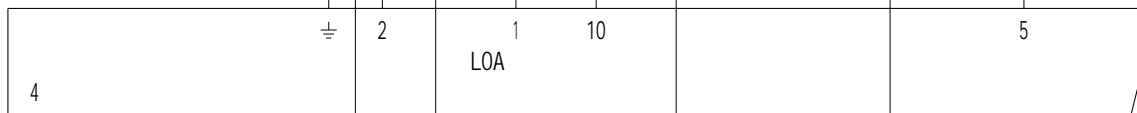

Stellantrieb  
Servomotor  
Damper motor

Y10

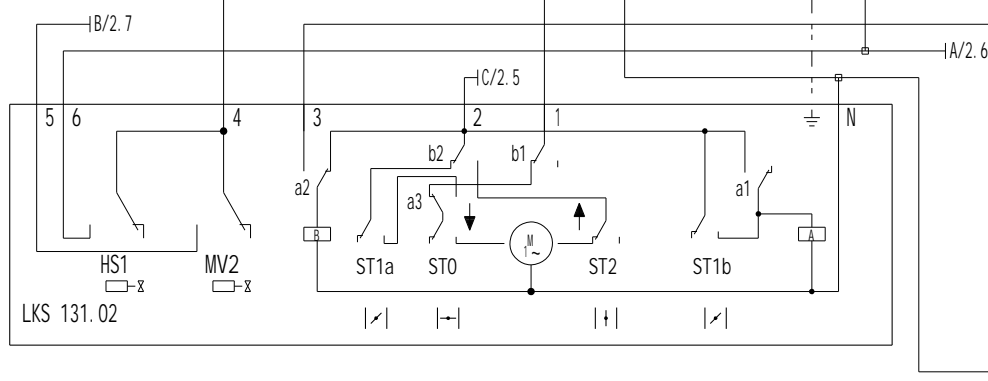

LKS 131.02

	Aend. /Modificati on	Dat.	Vis.	gepr. /dess.	Dat.	Vis.
a	AM 8317	17.07.95	Pru	gez. /dess.	09.02.96	dl
b	AM 8396	08.02.96	Pru	gez. /dess.	09.02.96	dl
c				gepr. /contr.	09.02.96	dl
d						



Art. N°:	13001174-B
Bez. /Des. 1	Schéma électrique
Bez. /Des. 2	Brûleur fuel 2 all

Type	C10. . 22 H201	Blatt/Page	1
Schema Draw.	L03. 1. 0018	Tot. Bl /Pg	3

A

B

C

D

E

F

Klemmen 31 und 32 fuer B-zaehler  
 vorverdrahtet  
 Bornes 31 et 32 en attente  
 pour compteur horaire  
 Terminal s 31 and 32 prewired  
 for hour run meter

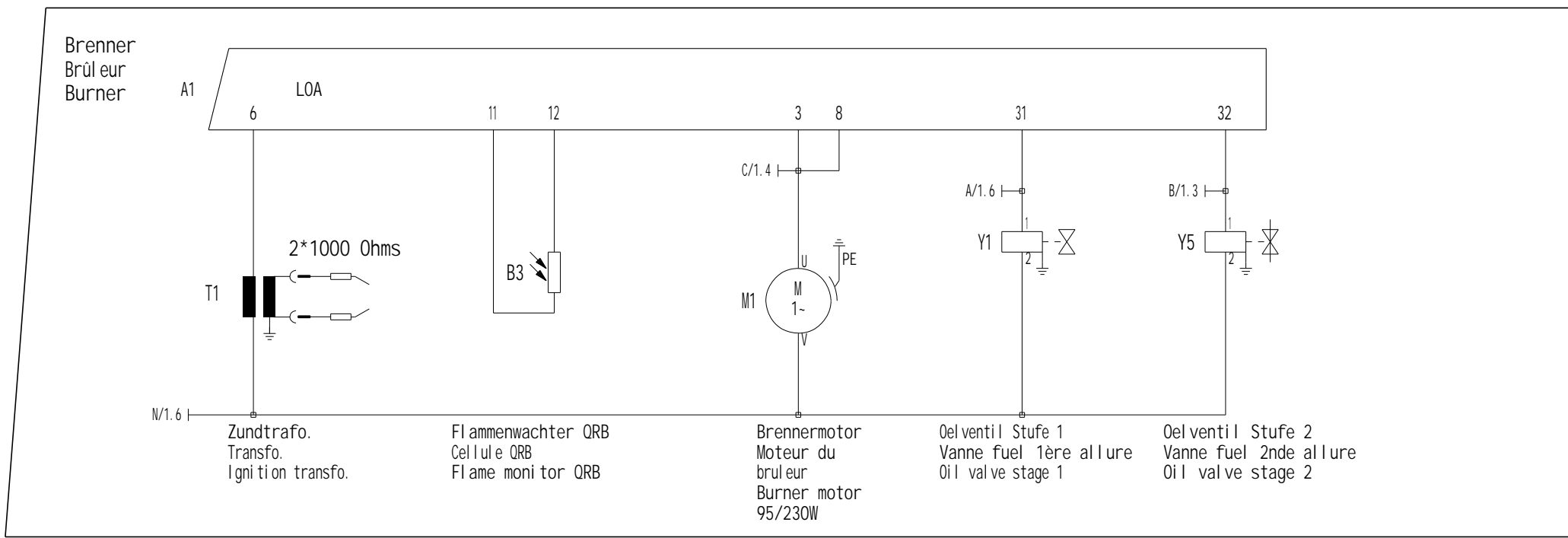

Aend. /Modifi cation	Dat.	Vis.	gez.	Dat.	Vis.
a AM 8317	17.07.95	Pru	gez.	09.02.96	dl
b AM 8396	08.02.96	Pru	dess.		
c			gepr.	09.02.96	dl
d			contr.		



Art. N°:	13001174-B	Type	C10. .22 H201	Blatt/Page	2
Bez. /Des. 1	Schéma électrique	Schema Draw.	L03. 1. 0018	Tot. Bl /Pg	3
Bez. /Des. 2	Brûleur fuel 2 al I				

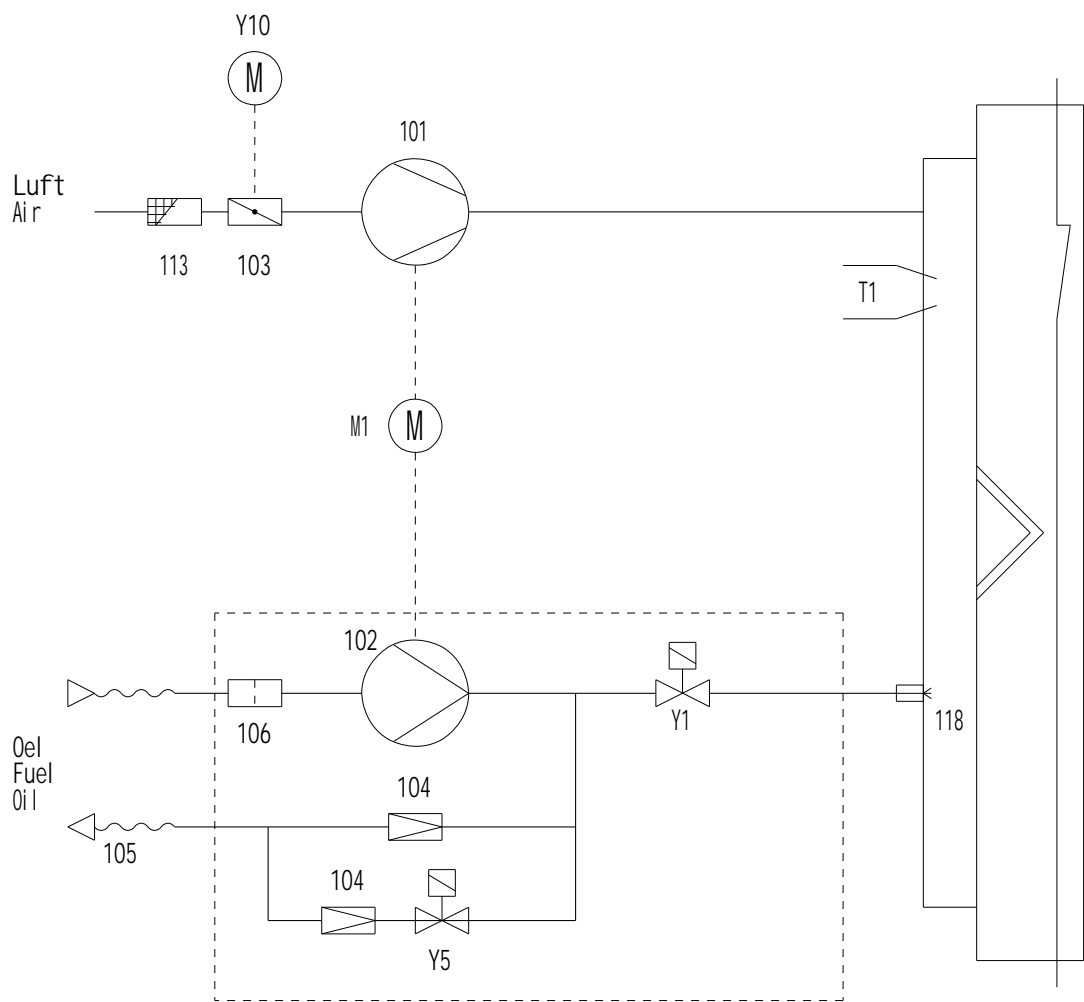

M1	Brennermotor	Moteur du bruleur	Burner motor
T1	Zundtrafo.	Transfo.	Ignition transfo.
Y1	Oelventil Stufe 1	Vanne fuel 1° allure	Oil valve stage 1
Y5	Oelventil Stufe 2	Vanne fuel 2° allure	Oil valve stage 2
Y10	Stellantrieb	Servomoteur	Damper motor
101	Ventilator	Ventilateur	Impeller
102	Pumpe	Pompe	Pump
103	Luftklappe	Volet d'air	Air-damper
104	Druckregler	Régulateur de pression	Pressure regulator
105	Schl auch	Flexible	Flexible
106	Filter	Filtre	Filter
113	Ansauggitter	Grille d'aspiration	Protection
118	Dusen	Gicleur	Nozzle

	Aend. /Modif ication	Dat.	Vis.	gez.	Dat.	Vis.
a	AM 8317	17.07.95	Pru	gez.	09.02.96	dl
b	AM 8396	08.02.96	Pru	dess.	09.02.96	dl
c				gepr.	09.02.96	dl
d				contr.	09.02.96	dl



Art. N°:	13001174-B	Type	C10. . 22 H201	Blatt/Page	3
Bez. /Des. 1	Schéma hydraulique	Schema Draw.	L03. 1. 0018	Tot. Bl /Pg	3
Bez. /Des. 2	Bruleur gaz 2 all.				