

A
B
C
D
E
F

Einspeisung
Alimentation
Power supply

Der Schutz der Anlage entspricht den geltenden Normen.
Protection de l'installation conforme aux normes en vigueur.
Protection of the installation in conformity with the actual norms.

Erdung nach örtlichen Vorschriften!
Mise à la terre conformément au réseau local!
Earthing in accordance with local regulation!

Tri 400V 50Hz/60Hz
L1 L2 L3

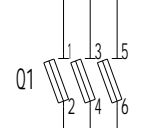

230V 50Hz/60Hz
N L1

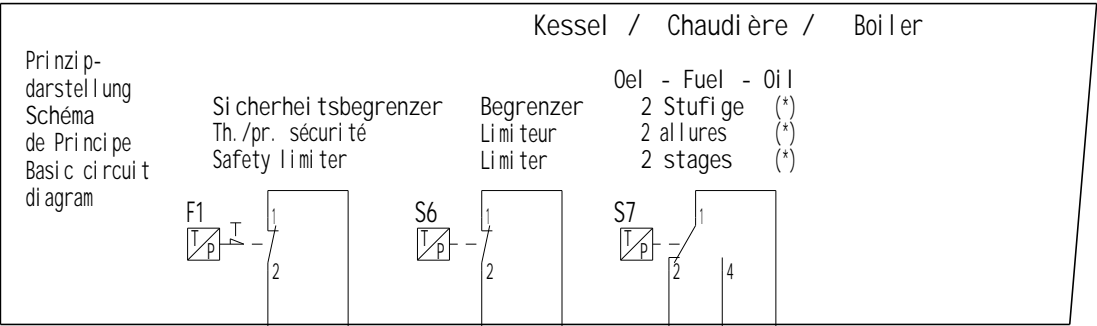
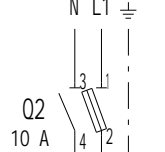

Brenner
Brûleur
Burner

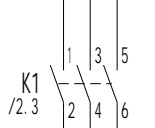

Steuersicherung
Fusible de commande
Control fuse

- Hauptklemmleiste
Bornier principal
Main terminals
- Interne Klemmleiste
Bornier interne
Internal terminals

K1 /2.3

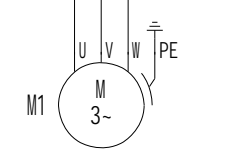
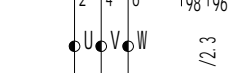

Brennermotor
Moteur du brûleur
Burner motor

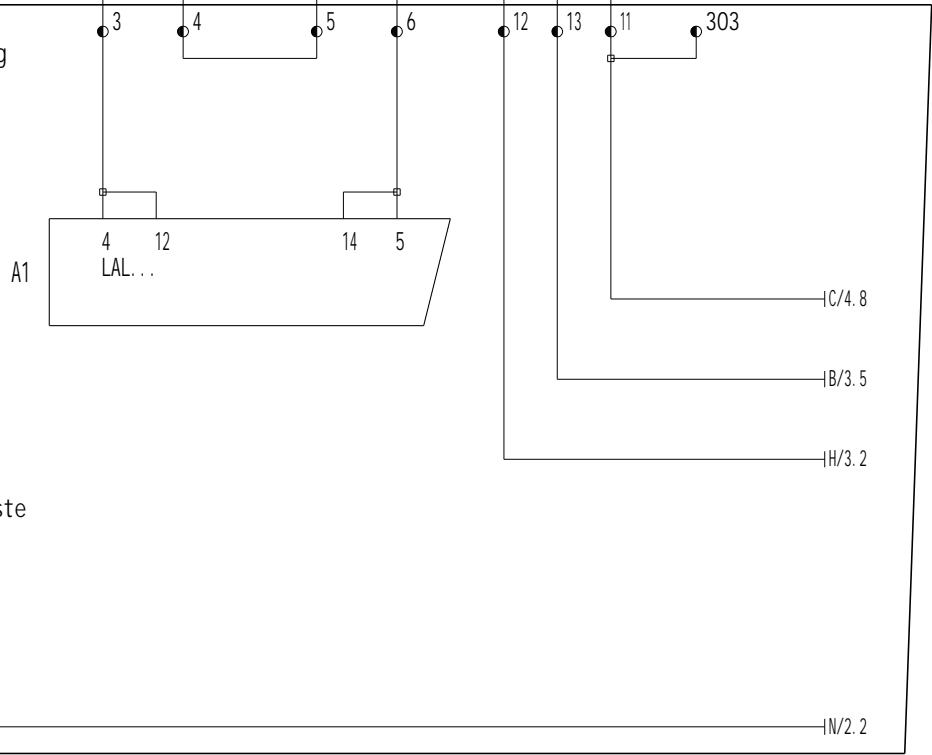

	Aend. /Modificati on	Dat.	Vis.		Dat.	Vis.
e	AM 8921	22.09.98	Pru	gez.	22.09.98	
f	AM 9364	02.11.00	Pru	dess.		
g				gepr.	22.09.98	
h				contr.		



Art. N°:	13001193-F	Type	C200/430 H501	Blatt/Page	1
Bez. /Des. 1	Schéma électrique	Schema Draw.	L03.1.0039	Tot. Bl./Pg	5
Bez. /Des. 2	Brûleur fuel				

A

B

C

D

E

F

Ein/Ausfernsteuerung
 Marche/arret par
 télécmande
 On/off at di stance

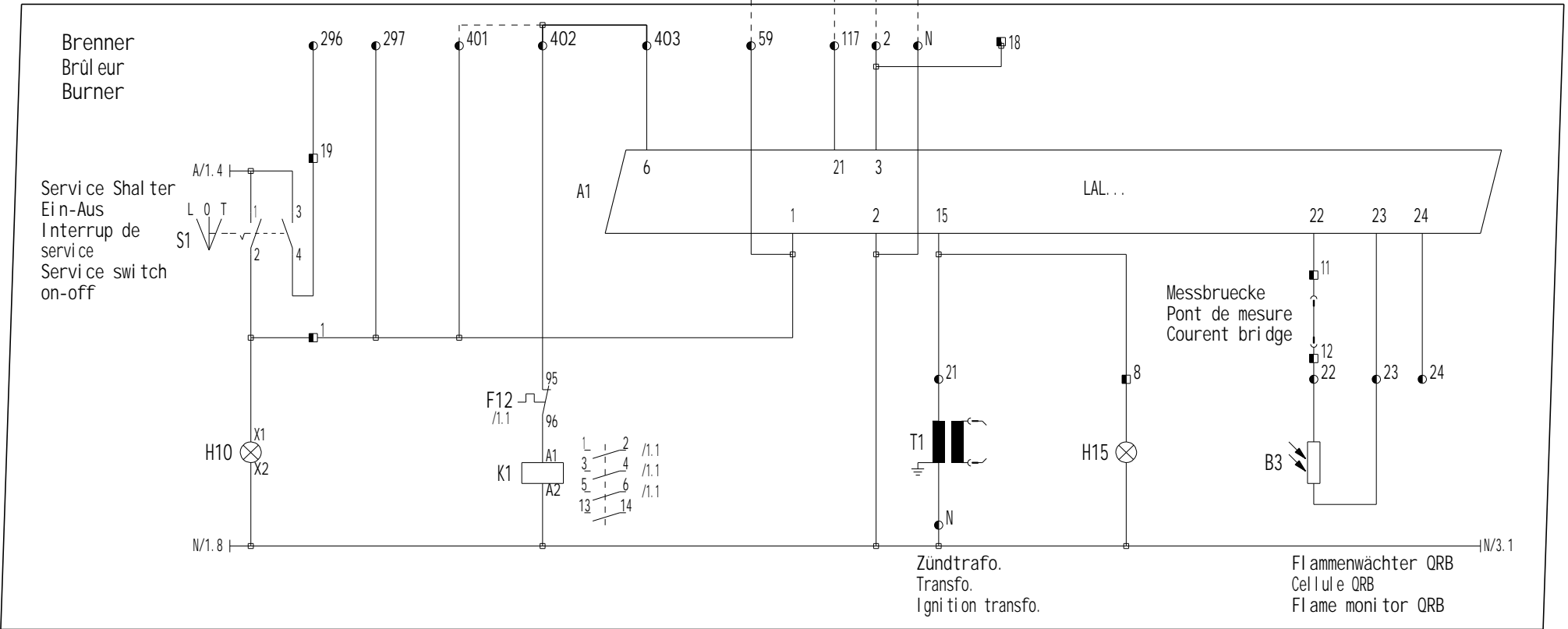
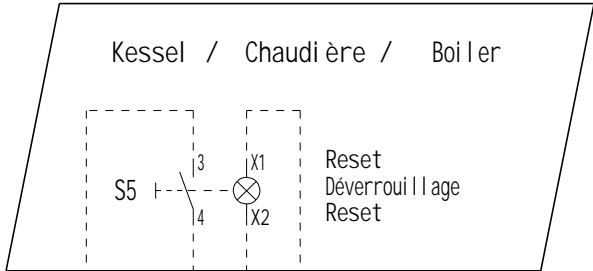

e	Aend. /Modi fi cation	Dat.	Vis.	Dat.	Vis.
f	AM 8921	22.09.98	Pru	22.09.98	
g	AM 9364	02.11.00	Pru		
h					



Art. N°:	13001193-F	Type	C200/430 H501	Blatt/Page	2
Bez. /Des. 1	Schéma él ectri que	Schema Draw.	L03.1.0039	Tot. Bl /Pg	5
Bez. /Des. 2	Brûleur fuel				

A

B

C

D

E

F

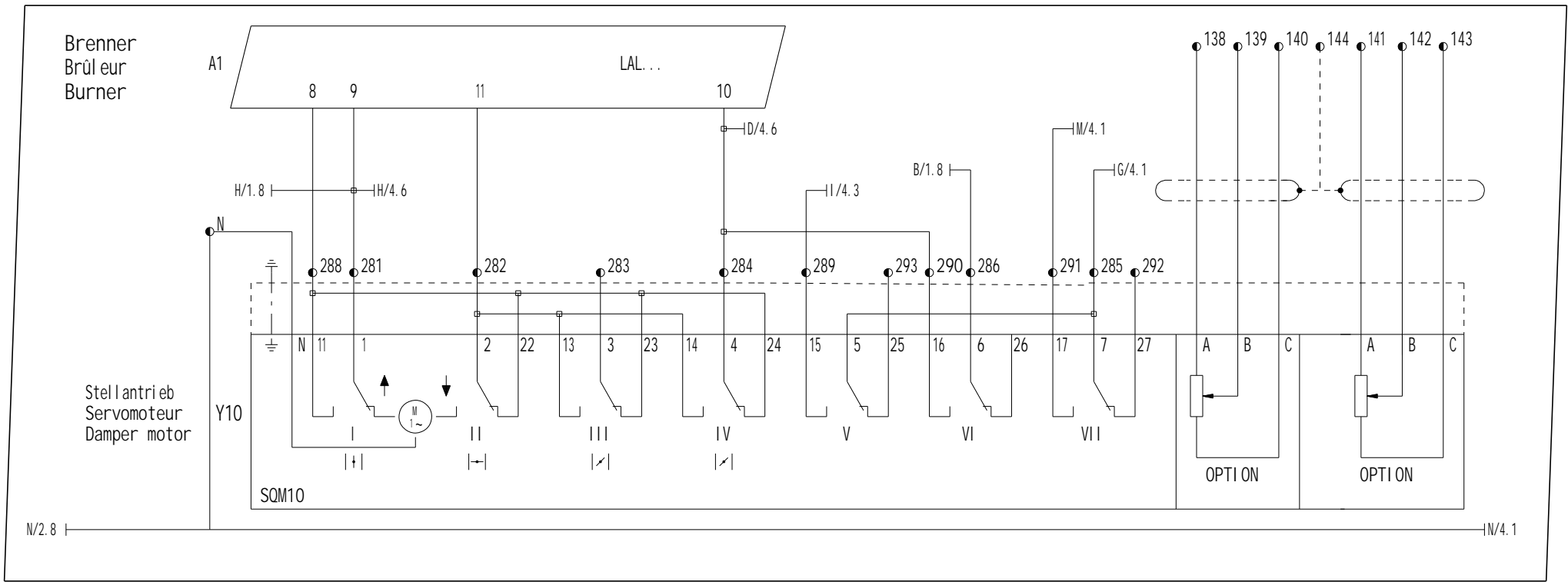

	Aend. /Modifi cation	Dat.	Vis.	gez.	Dat.	Vis.
e	AM 8921	22.09.98	Pru	gez.	22.09.98	
f	AM 9364	02.11.00	Pru	dess.		
g				gepr.	22.09.98	
h				contr.		



Art. N°:	13001193-F	Type	C200/430 H501	Blatt/Page	3
Bez. /Des. 1	Schema elctrique	Schema Draw.	L03.1.0039	Tot. Bl /Pg	5
Bez. /Des. 2	Brûleur fuel				

Regler/Régulation/regulation
 Gerber / Sondes / Sensors

	Y1	Y2	Y5
I	1	0	0
II	1	1	0
III	1	1	1

Brenner
 Brûleur
 Burner

●57 ●58 ●305 ●306 ●307 ●308 ●309

A1

18

LAL...

20

Shalter +/-
 Inter. +/-
 Selector switch +/-

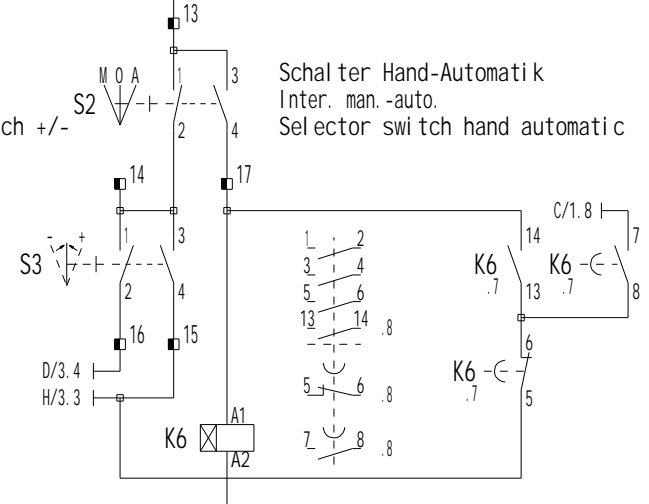

Schalter Hand-Automatik
 Inter. man.-auto.
 Selector switch hand automatic

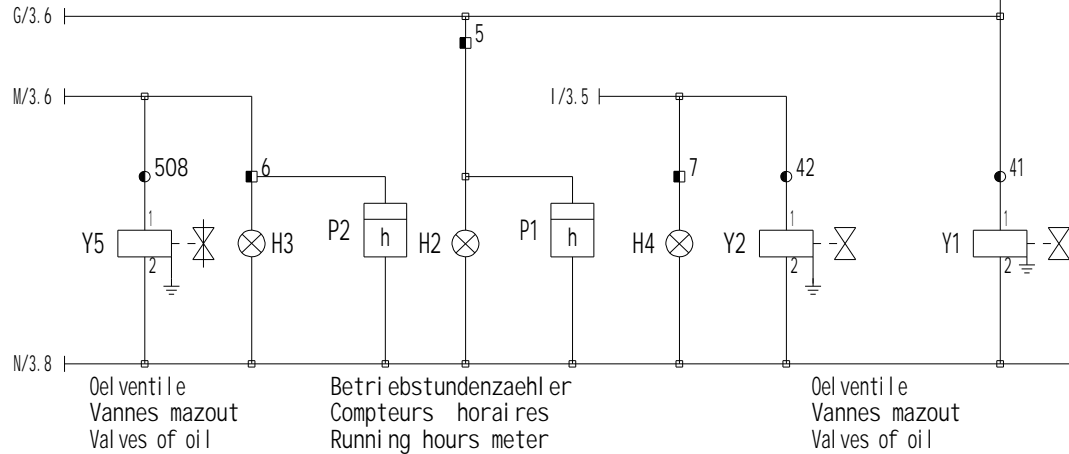

Oil valve
 Vannes mazout
 Valves of oil

Running hours meter
 Compteurs horaires
 Running hours meter

Oil valve
 Vannes mazout
 Valves of oil

	Aend./Modificati on	Dat.	Vis.	gepr.	Dat.	Vis.
e	AM 8921	22.09.98	Pru	gez.	22.09.98	
f	AM 9364	02.11.00	Pru	dess.		
g				gepr.	22.09.98	
h				contr.		



Art. N°:	13001193-F	Type	C200/430 H501	Blatt/Page	4
Bez./Des. 1	Schema electrique	Schema Draw.	L03.1.0039	Tot. Bl/Pg	5
Bez./Des. 2	Brûleur Fuel				

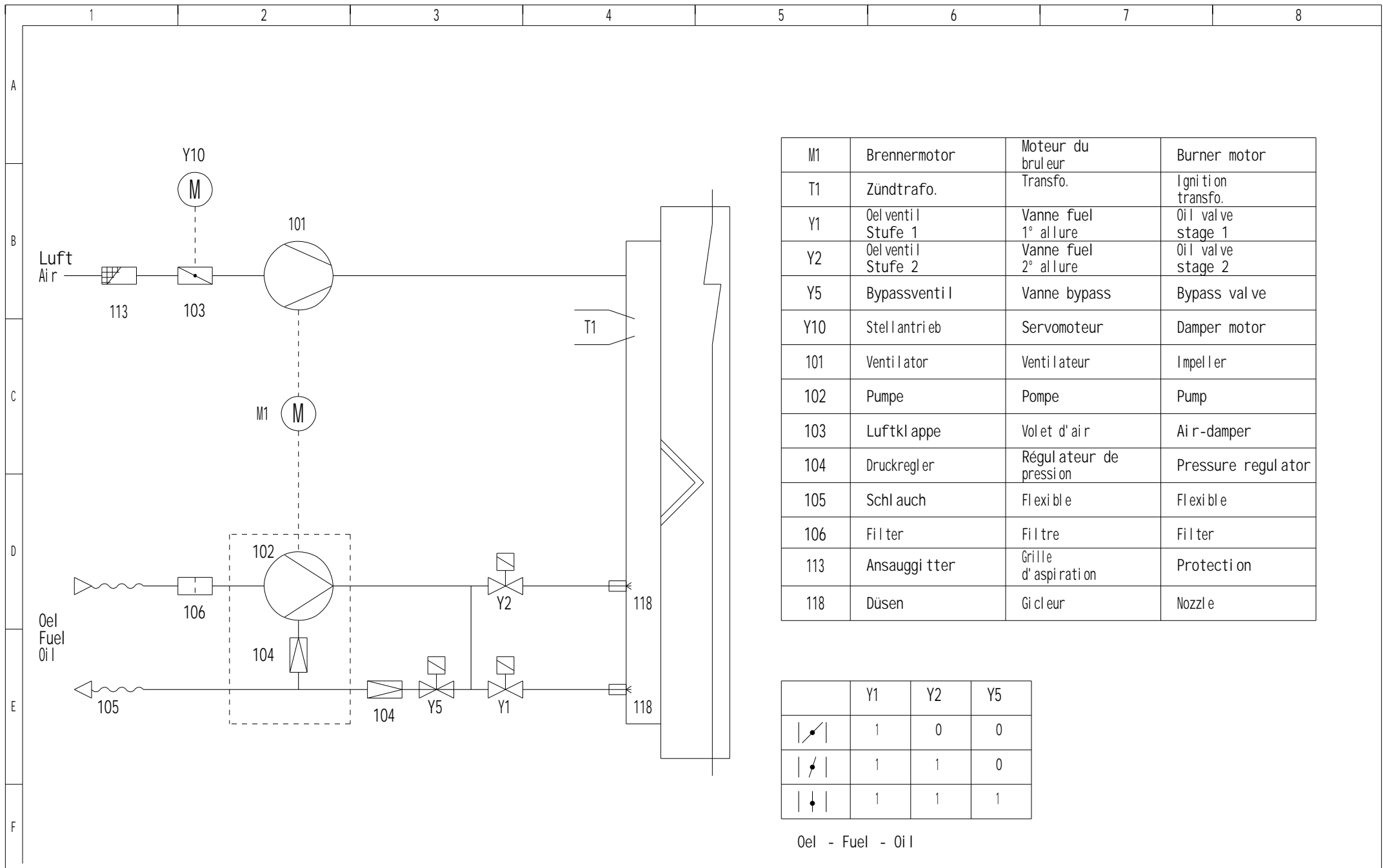

M1	Brennermotor	Moteur du bruleur	Burner motor
T1	Zündtrafo.	Transfo.	Ignition transfo.
Y1	Oelventil Stufe 1	Vanne fuel 1° allure	Oil valve stage 1
Y2	Oelventil Stufe 2	Vanne fuel 2° allure	Oil valve stage 2
Y5	Bypassventil	Vanne bypass	Bypass valve
Y10	Stellantrieb	Servomoteur	Damper motor
101	Ventilator	Ventilateur	Impeller
102	Pumpe	Pompe	Pump
103	Luftklappe	Volet d'air	Air-damper
104	Druckregler	Régulateur de pression	Pressure regulator
105	Schluch	Flexible	Flexible
106	Filter	Filtere	Filter
113	Ansauggitter	Grille d'aspiration	Protection
118	Düsen	Gicleur	Nozzle

	Y1	Y2	Y5
	1	0	0
	1	1	0
	1	1	1

Oel - Fuel - Oil

	Aend. /Modif ication	Dat.	Vis.	gez.	Dat.	Vis.
e	AM 8921	22.09.98	Pru	gez.	22.09.98	
f	AM 9364	02.11.00	Pru	dess.		
g				gepr.	22.09.98	
h				contr.		



Art. N°:	13001193-F	Type	C200/430 H501	Blatt/Page	5
Bez. /Des. 1	Schéma hydraulique	Schema Draw.	L03.1.0039	Tot. Bl /Pg	5
Bez. /Des. 2	Bruleur fuel				